

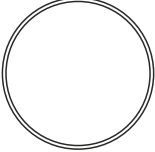

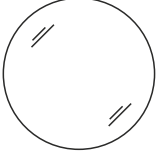

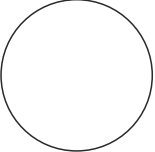



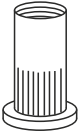
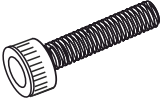
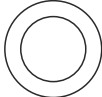

ROUND MIRROR

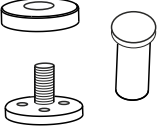

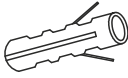
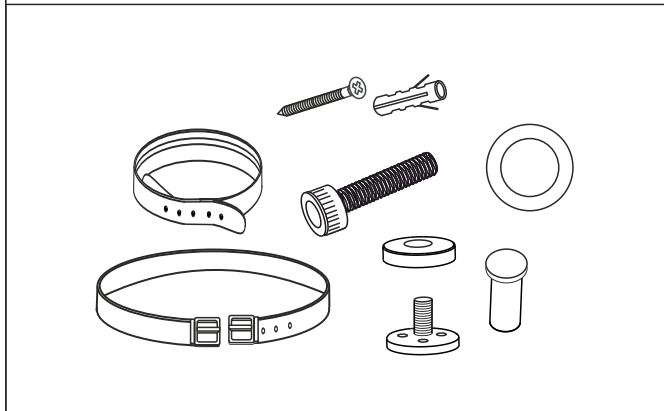
Delar / Dele / Deler / Osat / Osad / Hlutar / Spareparts / Pièces détachées / Onderdelen / Náhradní díly / Rezervni deli / Rezervni dijelovi

 <p>1</p>	 <p>2</p>	 <p>3</p>	 <p>4</p>	 <p>5</p>
 <p>6 3 x</p>	 <p>7 3 x</p>	 <p>8 1 x</p>	 <p>9 1 x</p>	 <p>10 1 x</p>
 <p>11 5 x (4x30 mm)</p>	 <p>12 5 x (6x30 mm)</p>			

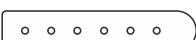

-  01-055-01-11 EAN 0200500269864
-  01-055-01-10 EAN 0200500269895
-  01-055-01-02 EAN 0200500269901
-  01-055-01-01 EAN 0200500269925

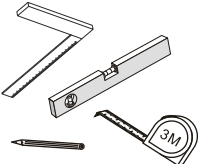
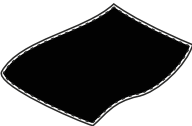
Verktøy / Værktøj / Verktø / Työkalut / Tööriistad / Verkfæri / Tools / Werkzeuge / Outils / Gereedschap / Nářadí / Orodja / Alati

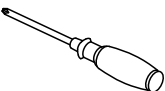
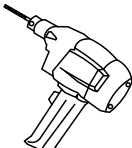
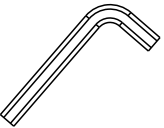
				 <p>Ø6 mm</p>	 <p>2.5 mm</p>
------------------------------------------------------------------------------------	-------------------------------------------------------------------------------------	-------------------------------------------------------------------------------------	--------------------------------------------------------------------------------------	----------------------------------------------------------------------------------------------------	-----------------------------------------------------------------------------------------------------

1

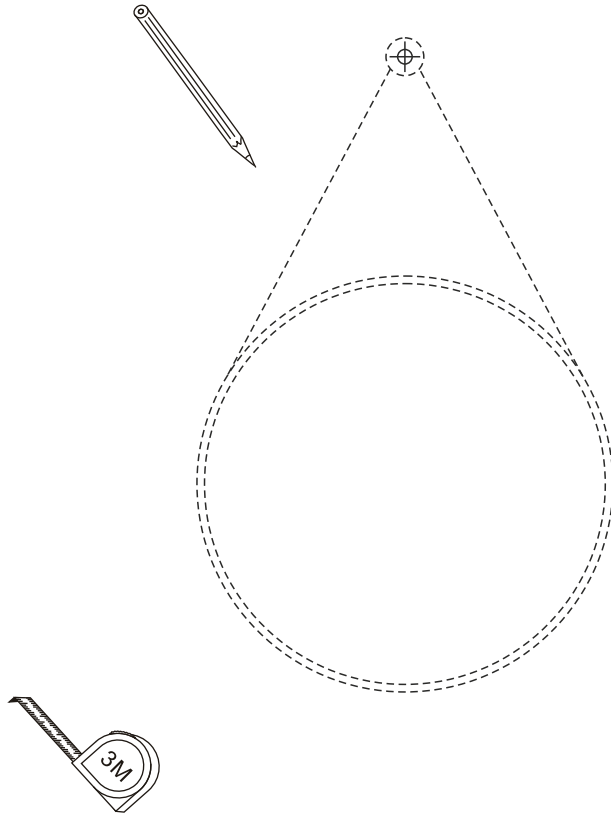

2

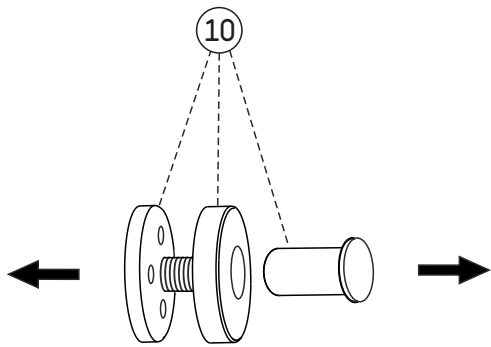

3

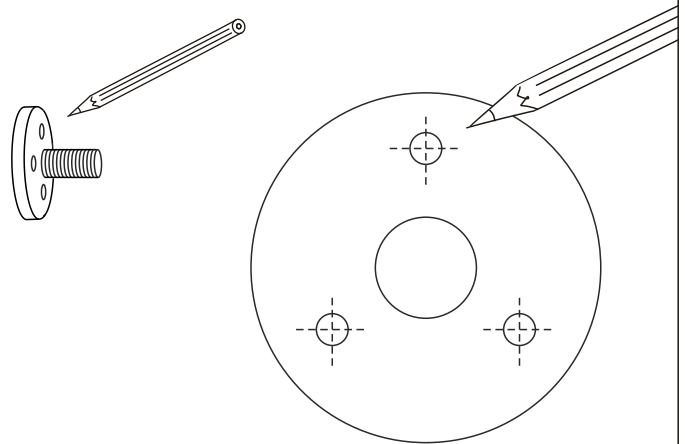

4

a

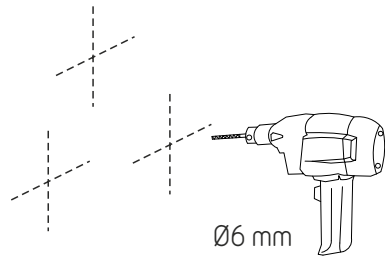

Ø6 mm

b

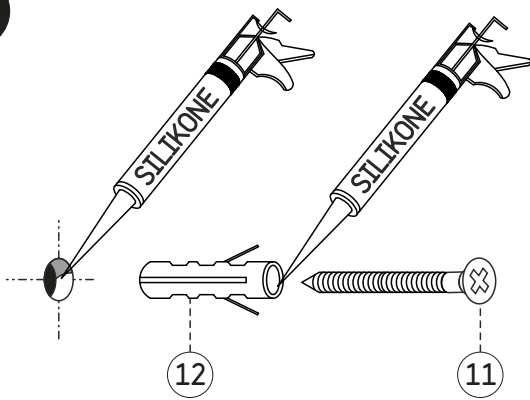

12

11

c



d

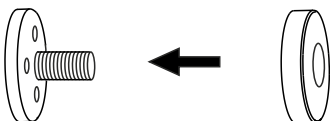

e

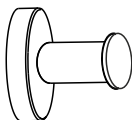

S Pluggar som följer med denna möbel är lämpliga endast för tegel- eller betongväggar. I falls dina väggar är byggda av annat material, köp speciella pluggar i närmaste gör-det-själv butik. Alla hål borrade i en vägg i badrum måste tätas med silikon. Vi rekommenderar att applicera silikonerna innan pluggar sätts i hål och en gång till när de är installerade. Först sedan bör skruvar skrivas in.

DK De medfølgende rawplugs er kun beregnet til murstens- eller betonvægge. Hvis du har en anden type væg, skal du købe de rawplugs der passer til denne type væg i dit lokale bygge-marked. Alle skruehuller der borer i væggen i et badeværelse, skal forsegles med silikon. Vi anbefaler at komme silikon i skrue hullet før du sætter rawpluggen i rawpluggen.

N De vedlagte veggpluggene må kun brukes i mur- eller betongvegger. Hvis du har en annen type vegg, må du selv kjøpe de pluggene som trengs til den typen vegg du har i et byggevarerhus. Alle skruehull du borer i baderomsveggen må forsegles med silikon. Vi anbefaler at du fyller silikon i skruehullet før du setter inn veggpluggen. Deretter fyller du silikon i veggpluggen før du fester skruen i veggpluggen.

FIN Tuotteen mukana toimitetut kiinnitystulpat on tarkoitettu ainoastaan tiili- tai betoniseiniin. Jos sinulla on toisentyyppinen seinä, sinun tulisi ostaa siihen sopivat kiinnitystulpat rautakauppialta. Kaikki kylpyhuoneeseen poraamasi ruuviaukot tulisi tiivistää silikonilla. Suosittelemme laittamaan silikonია ruuviaukkoon ennen kiinnitystulpan asentamista. Laita silikonია myös kiinnitystulppaan ennen ruuvien ruuvaamista.

EST Lisatud pistikupesad on mõeldud kasutamiseks ainult tellis- või betoonseintes. Kui Teil on teist tüüpi sein, peaksite ostma seinakontaktid, mis on seda tüüpi sente jaoks saadaval kohalikus tööstuskaupade kaupluses. Kõik kruviaugud, mis Te puurite vannitoa seinä, tuleb tihendada silikooniga. Me soovitame panna silikooni kruviaukudesse enne sinakontakti paigaldamist. Siis pange silikooni pistikupesaaile enne kui selle kruviga seinale kinnitate.

IS Skruf tapparnir eru aðeins ætlaðir í hlaðna eða steypa veggi. Ef um er að ræða annars konar vegg skal kaupa skruf tappa fyrir þá gerð af veggjum í næstu DIY-verslun. Þetta skal öll skrufugöt, sem boruð eru í vegginn á badherberginu, með silikon. Við mælum með að látið sé silikon í skrufugatið áður en tappinn er látinn í gatið. Síðan læturðu silikon í skruf tappann áður en þú festir skrufuna í tappann.

GB The wall plugs included are only to be used in brick- or concrete walls. If you have another type of wall you should buy the wall plugs required for that type of walls in your local DIY-store. All screw holes you drill in the wall in a bathroom should be sealed with silicone. We recommend that you put silicone into the screw hole before you insert the wall plug. Then you put silicone into the wall plug before you fix the screw into the wall plug.

D Die mitgelieferten Dübel sind ausschließlich für Ziegel- oder Betonwände geeignet. Falls Ihre Wände aus anderen Materialien bestehen, sollten Sie in einem Baumarkt die entsprechenden Dübel kaufen. Alle in die Badezimmerwände gebohrten Löcher müssen mit Silikon versiegelt werden. Wir empfehlen, erst Silikon in die Schraublöcher zu spritzen, bevor Sie die Dübel in die Löcher schieben. Anschließend spritzen Sie Silikon in die in die Löcher geschobenen Dübel und drehen dann die Schrauben ein.

F Les chevilles incluses ne conviennent que pour des murs en brique ou en béton. Si vous avez un autre type de mur, vous devez acheter les chevilles requises pour ce type de mur dans votre magasin de bricolage. Tous les trous de vis percés dans les murs de la salle de bain doivent être protégés avec du silicone. Nous vous recommandons de mettre du silicone dans le trou de vis avant d'y insérer la cheville. Mettez ensuite le silicone dans la cheville avant d'y insérer la vis.

NL De bijgeleverde pluggen dient u alleen te gebruiken voor bakstenen- of betonnen muren. Indien u een ander soort muur hebt, dient u daarvoor de juiste pluggen aan te schaffen. We adviseren dat u in alle geboorde gaten in de muur van de badkamer siliconenkit aanbrengt. Vul eerst het geboorde gat in de muur op met siliconenkit, duw de plug in het gat. En vul dan de plug met siliconenkit voordat u de schroef in de plug draait.

CZ Hmoždinky dodávané spolu s kabinou jsou určeny pouze do cihlových nebo betonových zdí. Pokud máte jiný typ stěny, měli byste použít ty hmoždinky, které jsou určeny pro typ zdi, který máte doma. Všechny díry pro šroubky, které vyvrtáte, by měli být utěsněny silikonem. Doporučujeme instalovat trochu silikonu do vyvrtané díry dříve než vložíte hmoždinky, poté instalujte silikon také do samotné hmoždinky.

SI Priloženi vložki so primerni izključno za betonske ali opečnate stene. Če so vaše stene narejene iz drugih materialov, potem v gradbeni trgovini kupite ustrezne vložke. Vse luknje, ki jih boste izvrtali v kopalnici, je potrebno zatesniti s silikonom. Priporočamo vam, da najprej naneseite silikon, preden v luknjo potisnete vložek. Nato silikon naneseite še v odprtino vložka preden privijete vijak.

HR Tiple, koje su uključene u dostavu, smiju se koristiti samo za ciglene i betonske zidove. Ako imate neki drugi tip zida, kupite odgovarajuće tiple za taj tip zida u Vašoj lokalnoj željezariji. Sve rupe probušene u zidu kupaonice zabrtvite silikonom. Prije stavljanja tiple ispunite rupu silikonom. Ispunite tiplu silikonom prije nego što zavijete vijak.

5

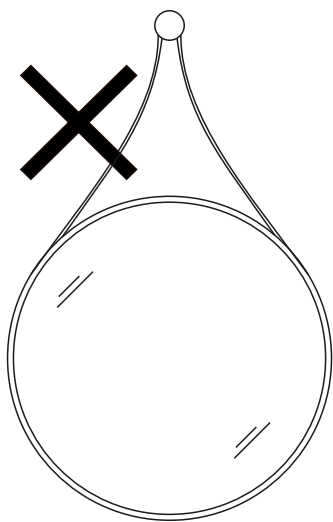
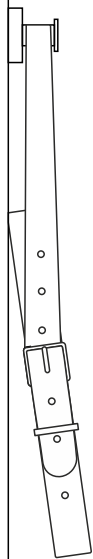
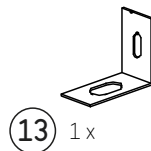
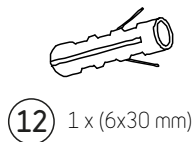
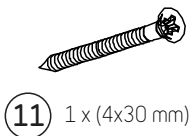

13

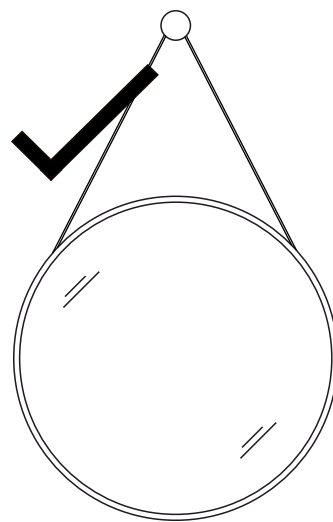

a

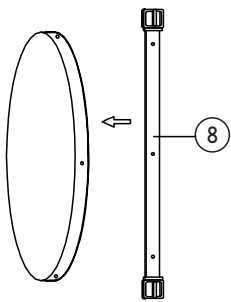

b

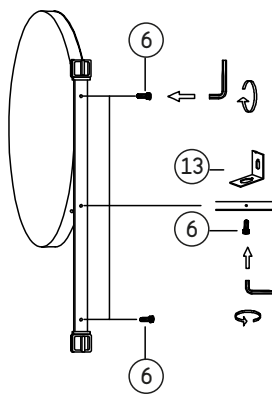

c

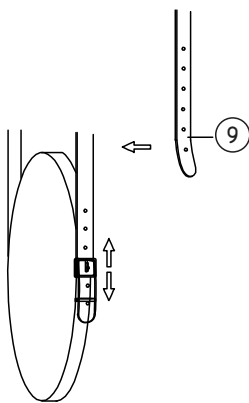

d

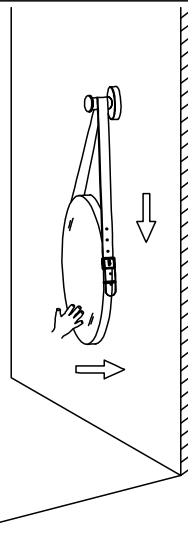

e

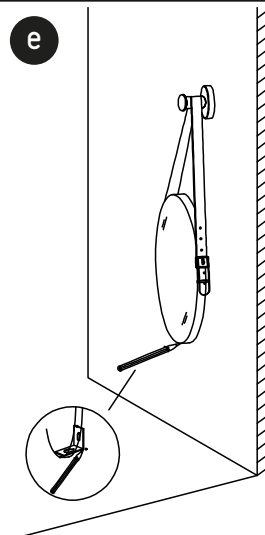

f

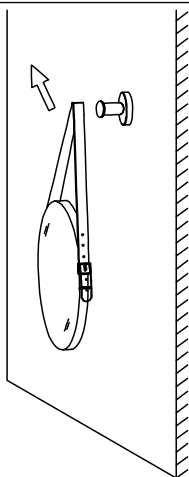

g

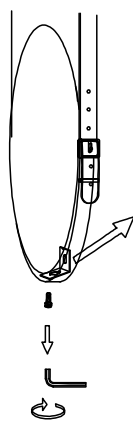

h

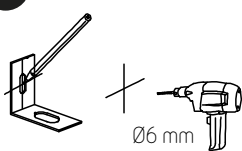

i

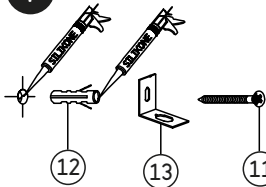

j

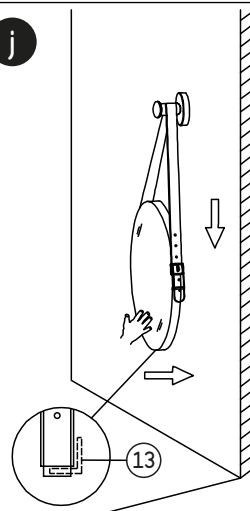

k

